

DOOR DESIGNS

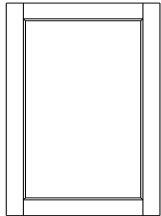

10

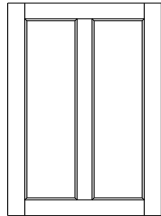

11

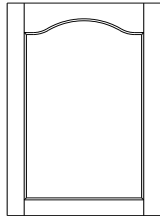

20

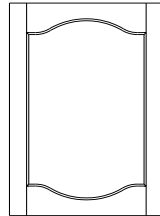

22

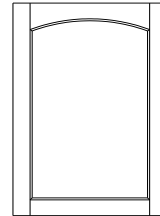

30

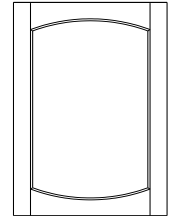

32

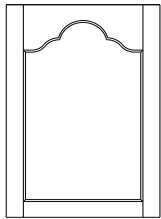

40

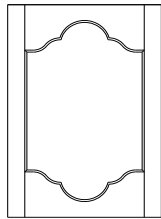

42

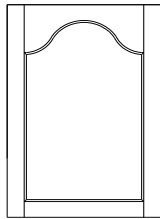

50

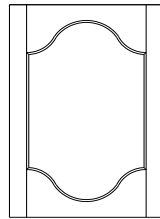

52

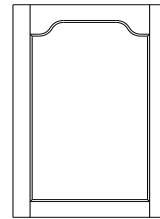

70

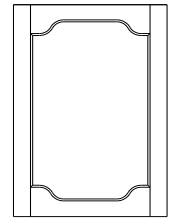

72

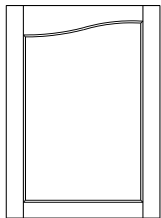

80

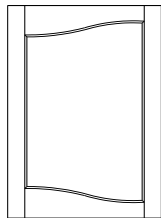

82

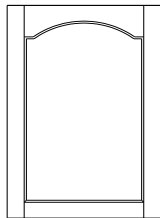

90

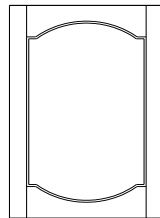

92

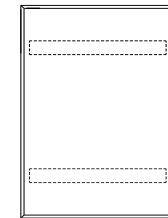

SLAB

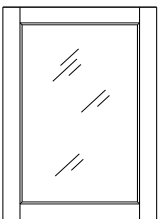

10G

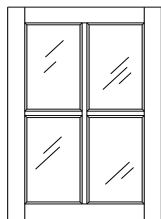

10G4
w/grids

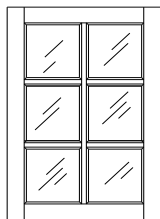

10G6
w/grids



DF1S (Solid Slab)
DF1V (Veneer Slab)

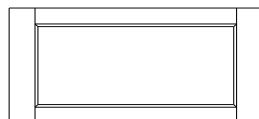

DF2

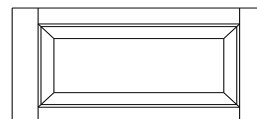

DF3

Inside Edge Profiles - Cope & Stick Doors

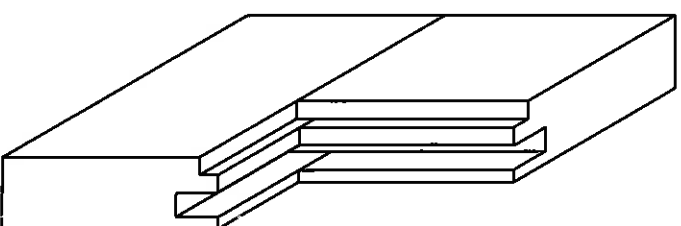
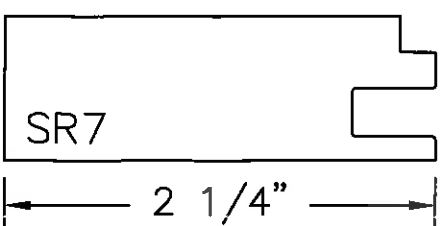
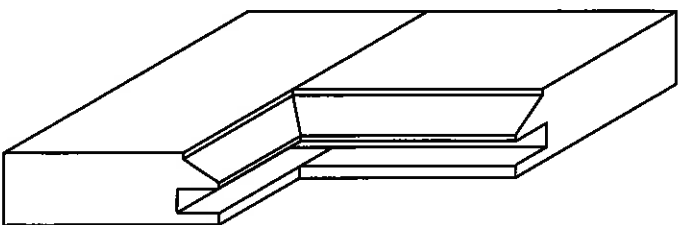
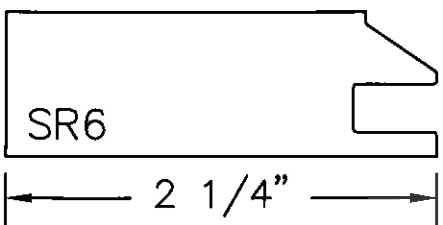
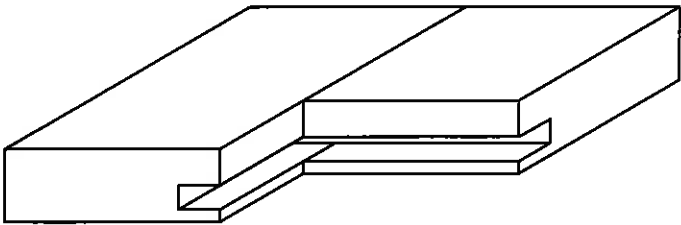
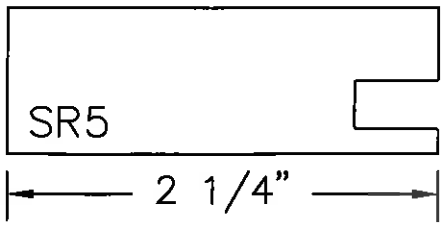
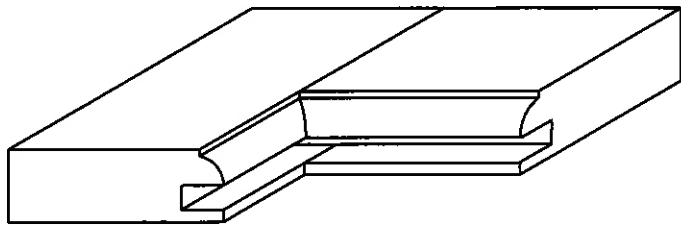
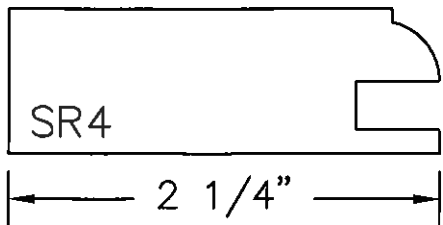
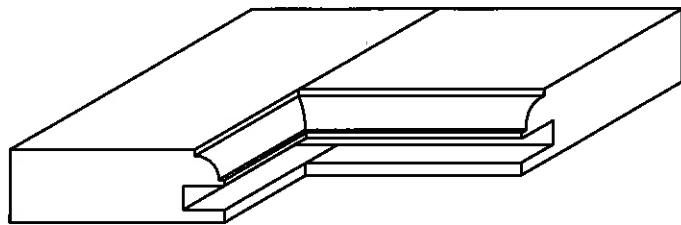
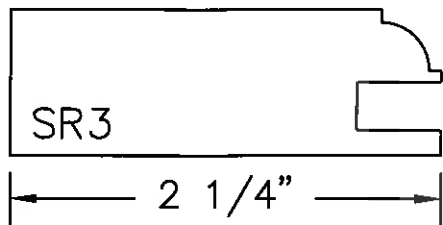
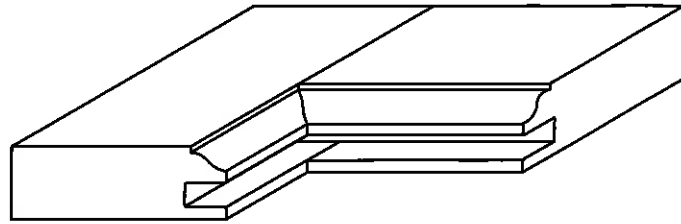
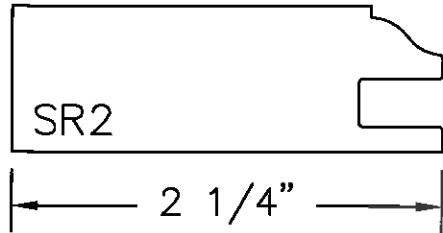

Inside Edge Profiles - Mitred Doors

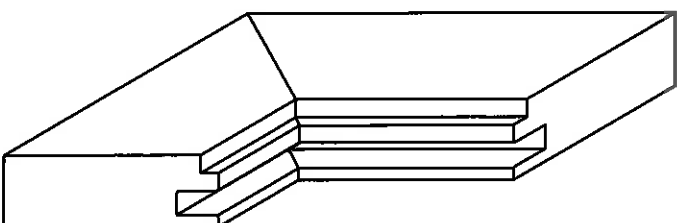
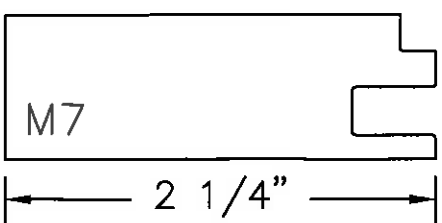
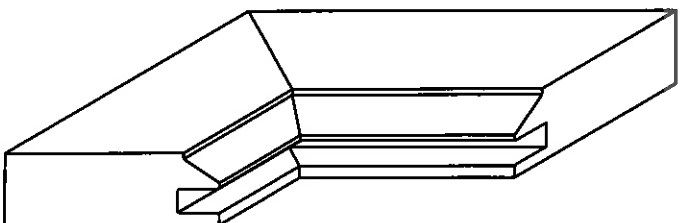
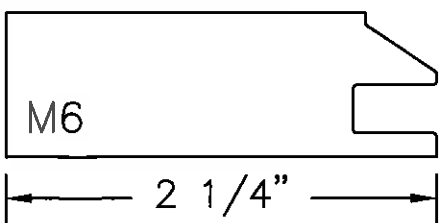
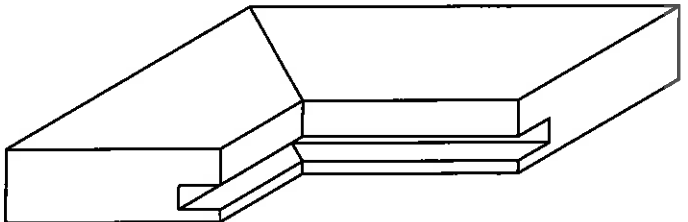
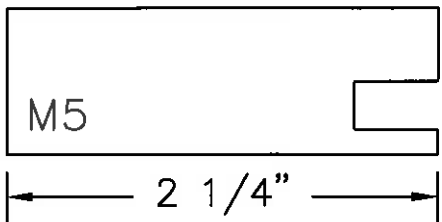
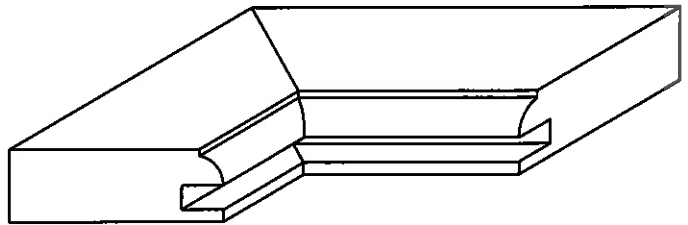
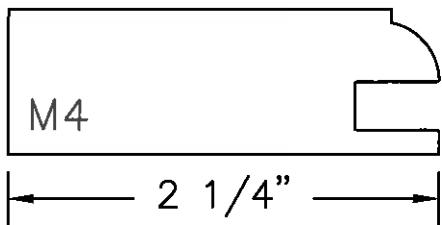
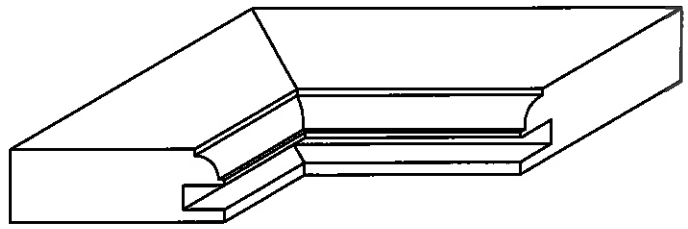
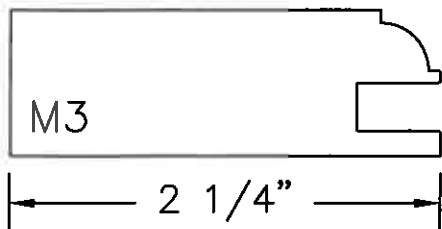
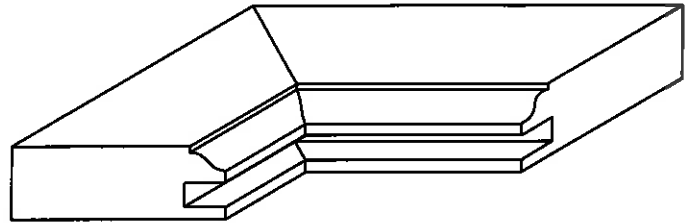
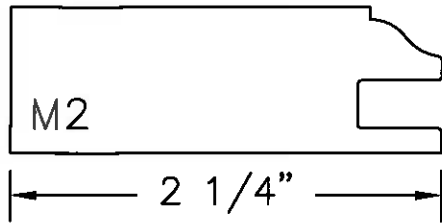

Standard stile and rail width is 2 1/4" - 3 & 3 1/2" widths available for a small up-charge, please specify upon order

Mitred Stile and Rail Doors

Door Profile

Drawer Front Profile

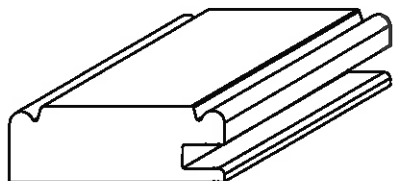
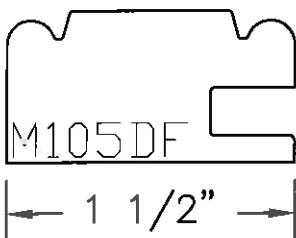
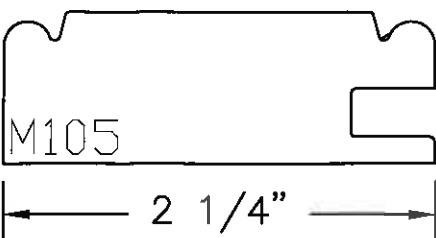
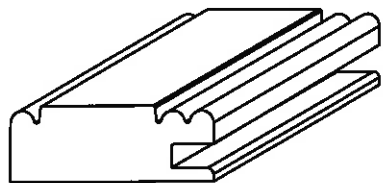
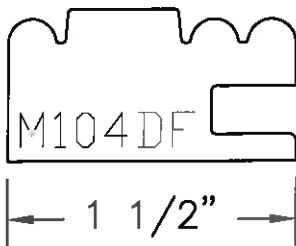
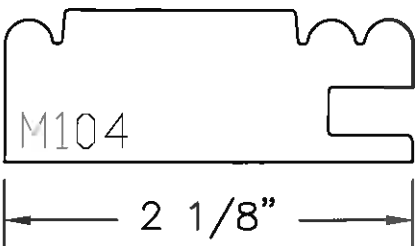
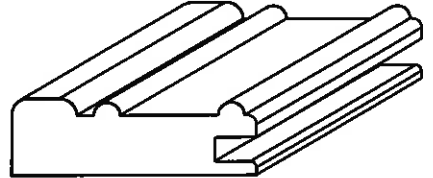
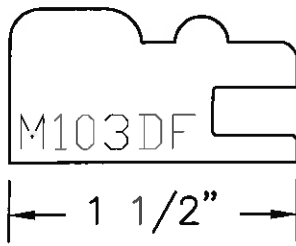
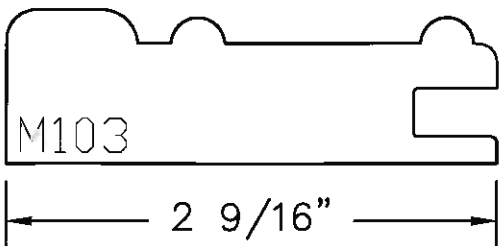
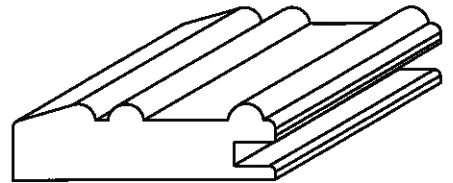
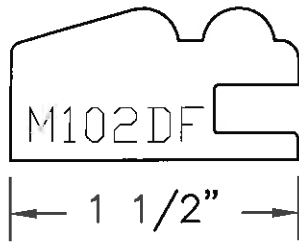
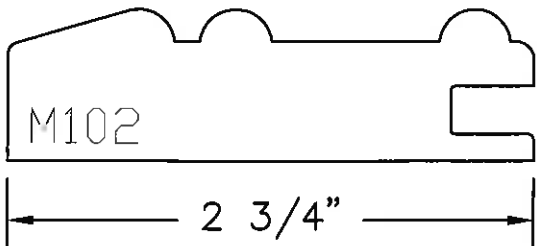
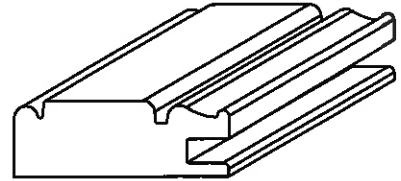
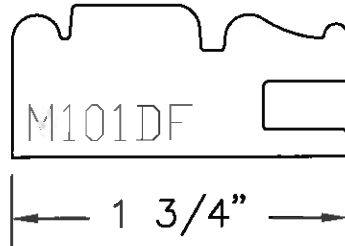
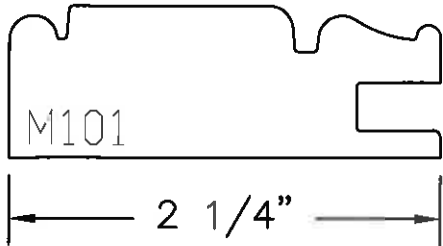

Note: No selections required for inside or outside edge profiles

Mitred Stile and Rail Doors

Door Profile

Drawer Front Profile

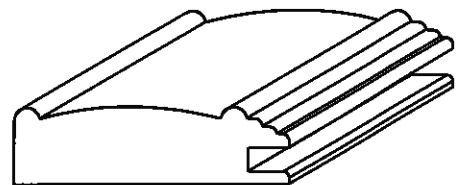
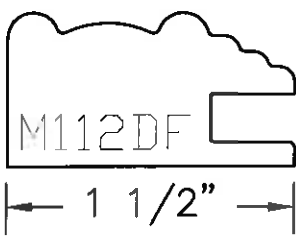
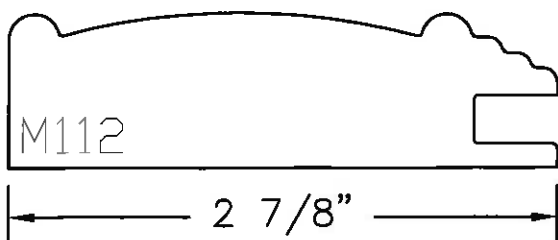
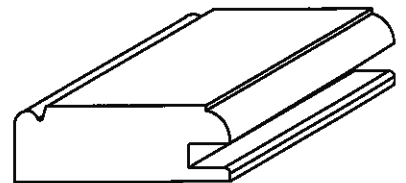
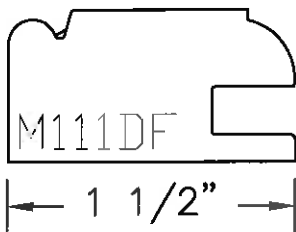
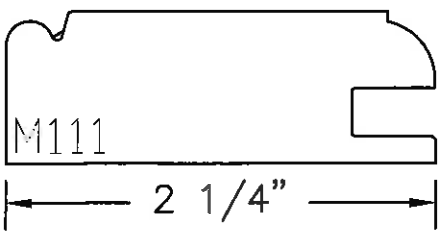
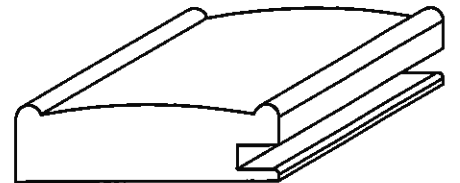
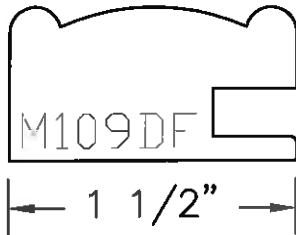
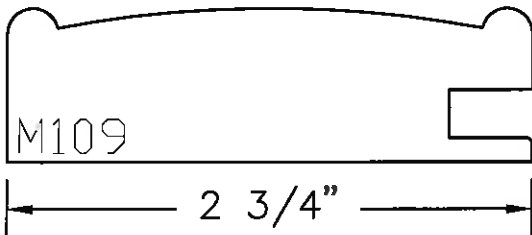
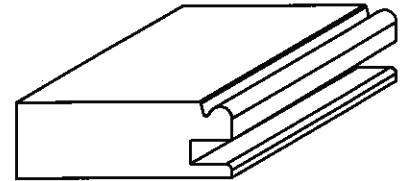
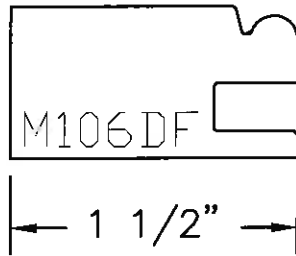
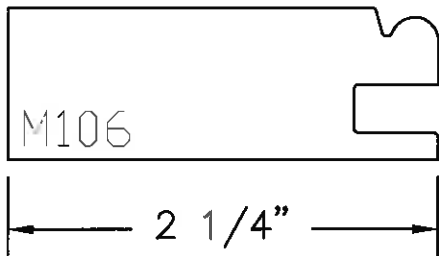
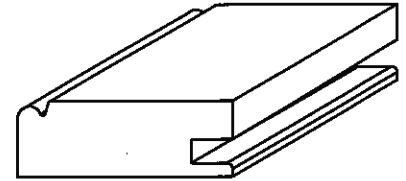
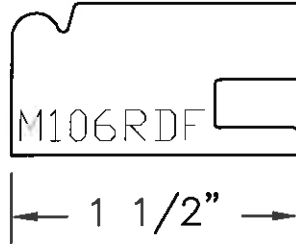
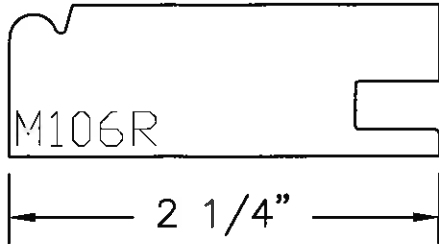

Note: No selections required for inside or outside edge profiles

Mitred Stile and Rail Doors

Door Profile

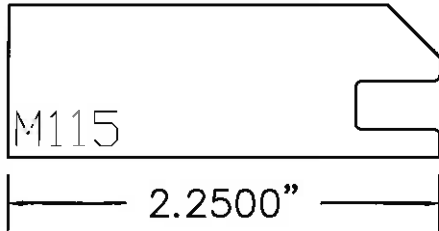

Drawer Front Profile

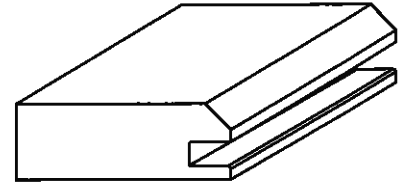
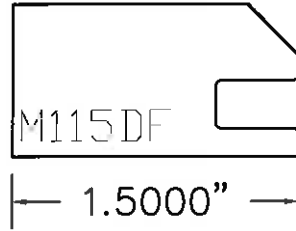

Mitred Stile and Rail Doors with Recessed Bead/Rope Mouldings

Door Profile

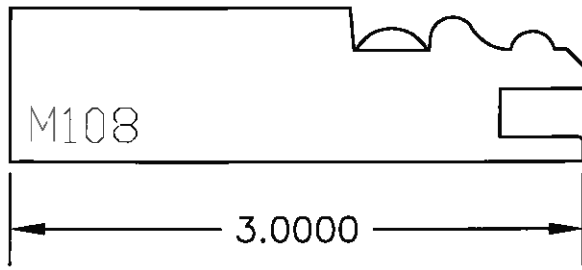

Drawer Front Profile

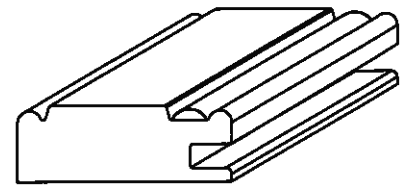
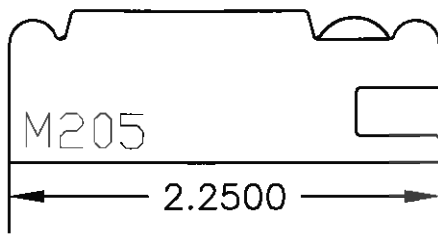
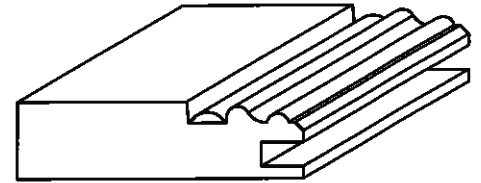
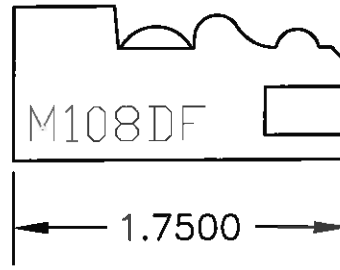

Insert



Bead
 Moulding



Rope
 Moulding

Outside Edge Profiles for Doors and Drawers

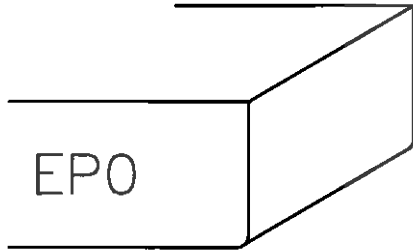

EP0

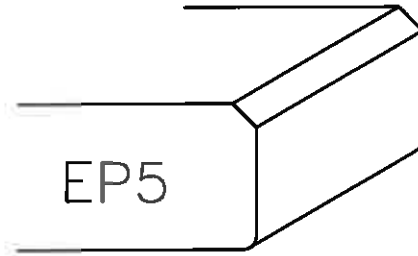

EP5

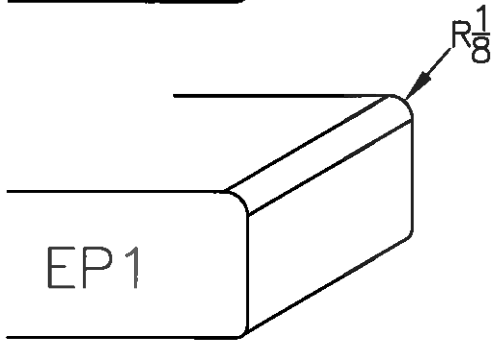

EP1

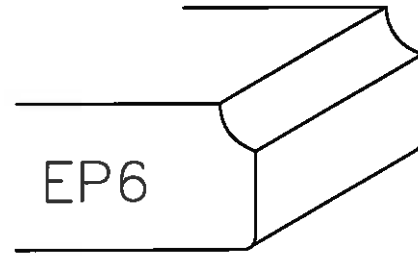

EP6

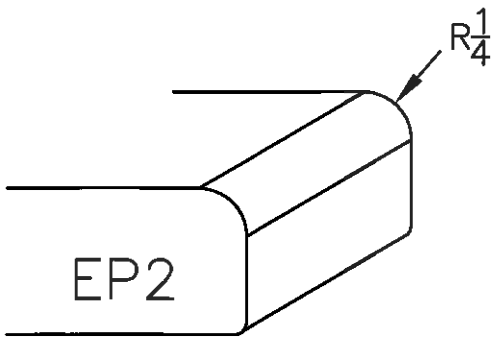

EP2

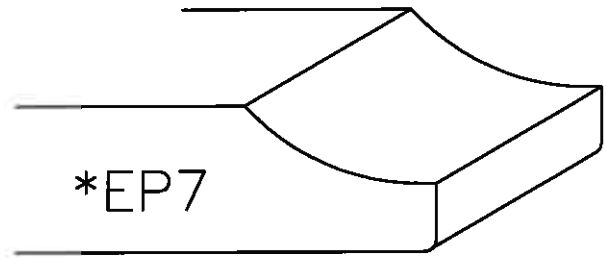

*EP7

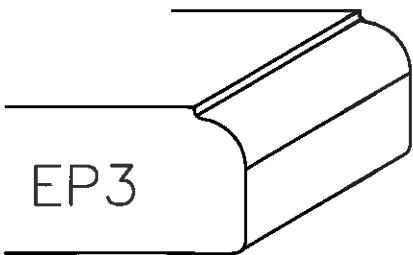

EP3

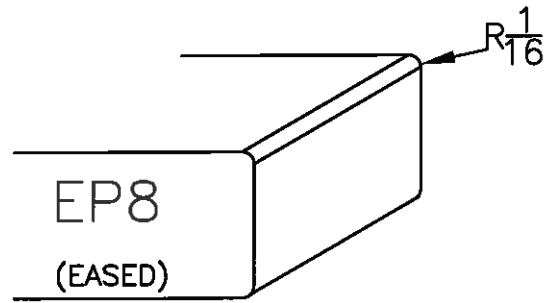

EP8
(EASED)

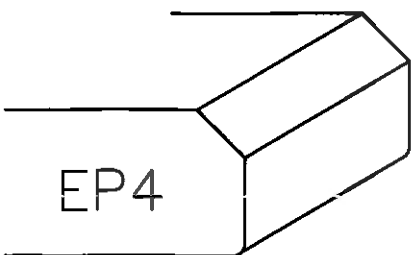

EP4

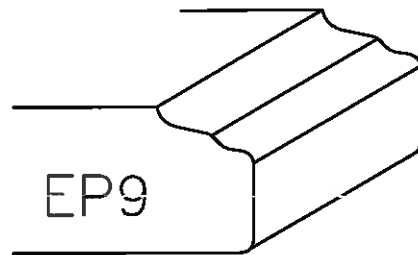

EP9

Outside Edge Profiles for Doors and Drawers

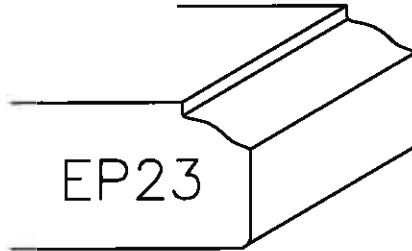
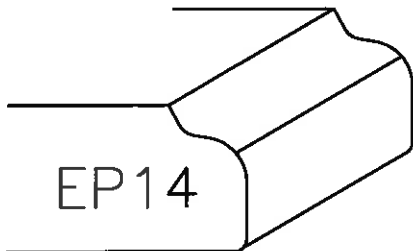
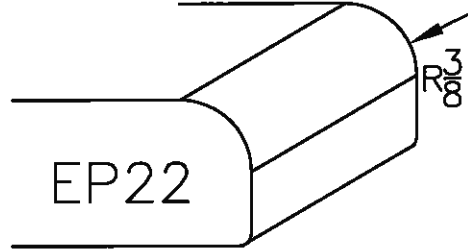
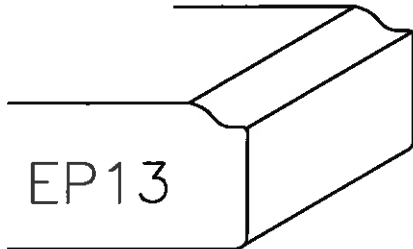
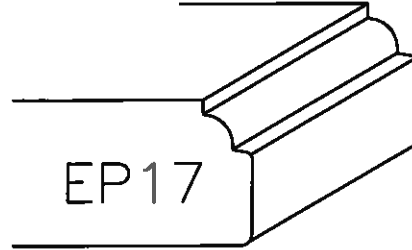
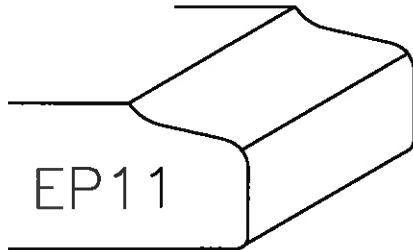

SLAB DOOR & DRAWER ONLY PROFILE

*Slab drawer front only option

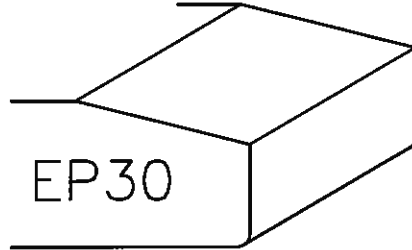

SLAB DRAWER ONLY PROFILES

*Slab drawer front only option

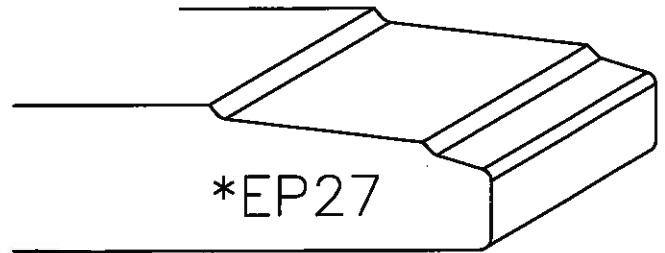
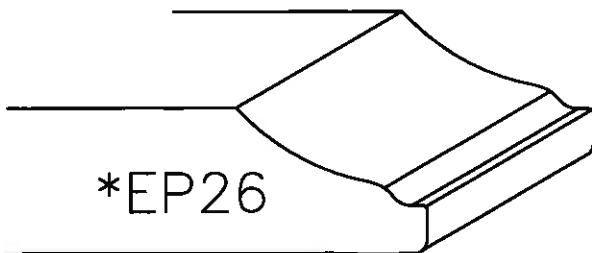

Center Panel Profiles

SOLID RAISED PANEL PROFILES

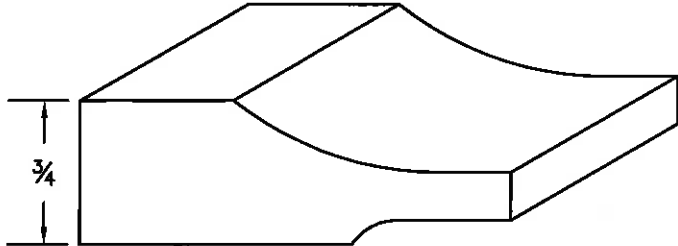

PP1

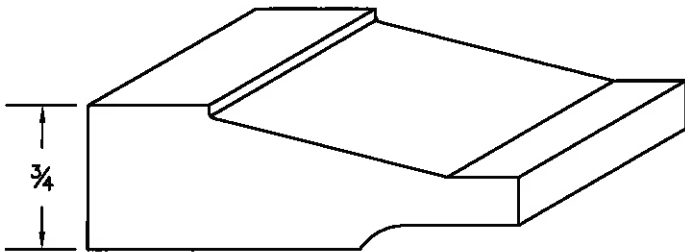

PP2

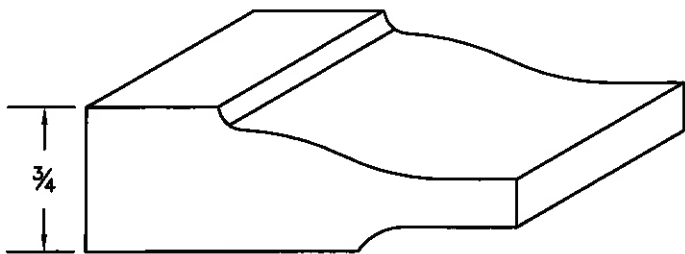

PP3

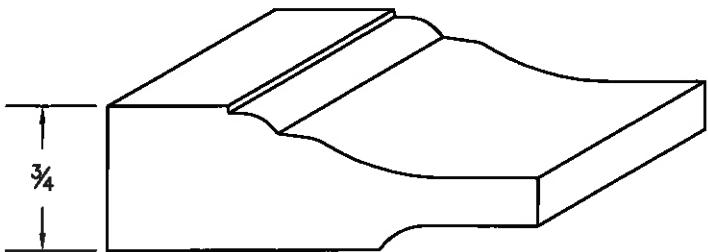

PP4

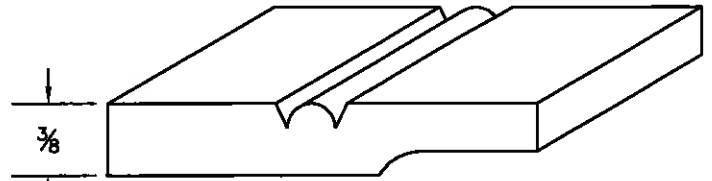

PP5

Bead centered (1 1/2" spacing)
 other spacing options available

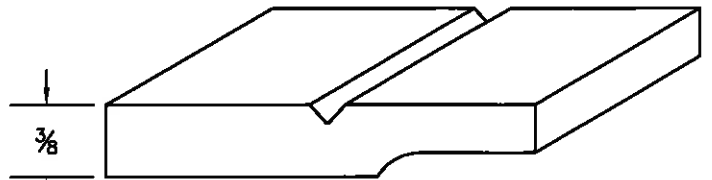

PP6

V-Groove centered (1 1/2" spacing)
 other spacing options available

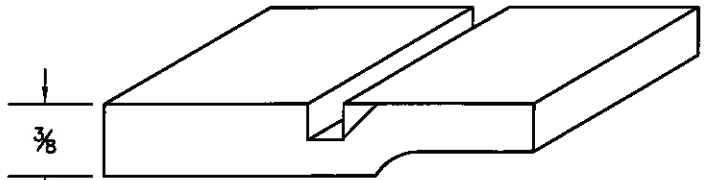

PP10

Groove centered (2" spacing)
 other spacing options available

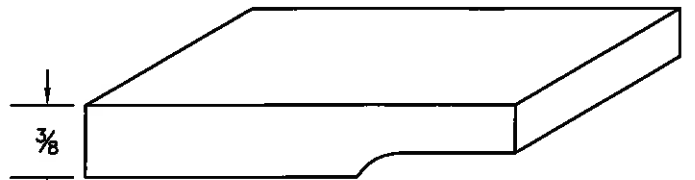

PP7

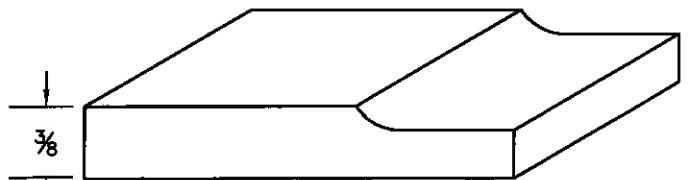

PP9

Center Panel Profiles

VENEER FLAT PANEL PROFILES

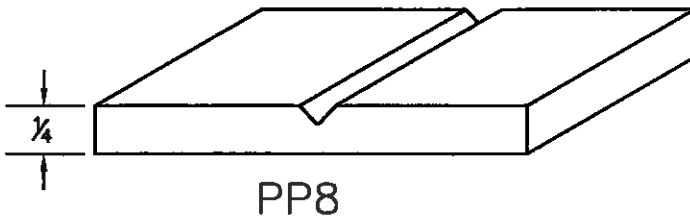
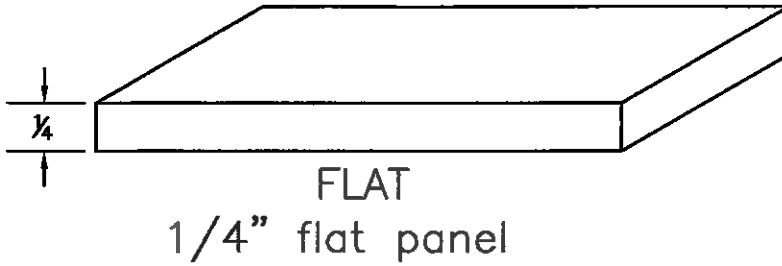

V-Groove centered (1 1/2" spacing)
other spacing options available

Applied Moulding Doors

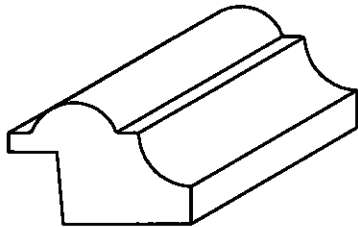

APM001
 5/8" x 15/16"

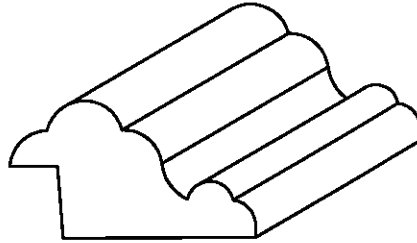

APM002
 11/16" x 1 5/16"

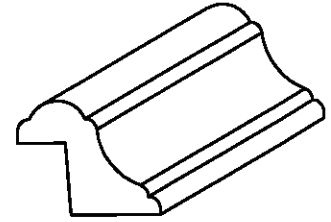

APM003
 1/2" x 3/4"

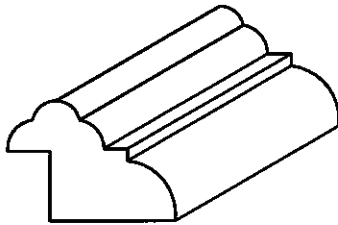

APM004
 5/8" x 7/8"

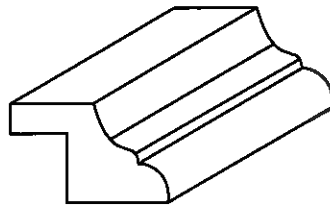

APM005
 1/2" x 13/16"



APM006
 1/4" x 9/16"

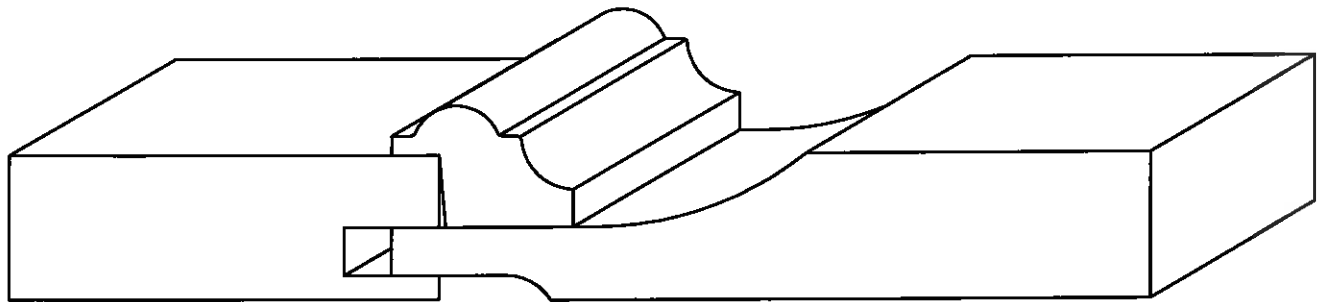

APPLIED MOULDING ON RAISED PANEL DOOR
 - PANEL PROFILE #1 SHOWN

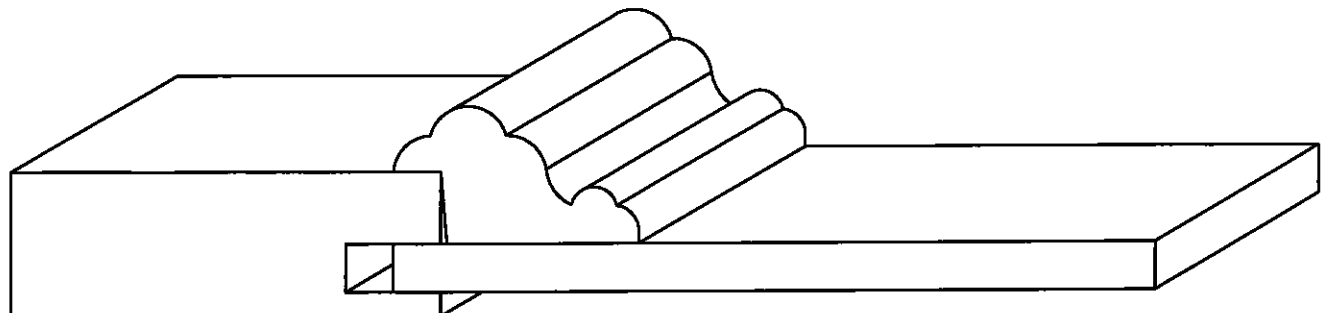

APPLIED MOULDING ON 1/4" FLAT PANEL DOOR

Cross-Section of Raised Panel Door

Finished Thickness is 3/4"

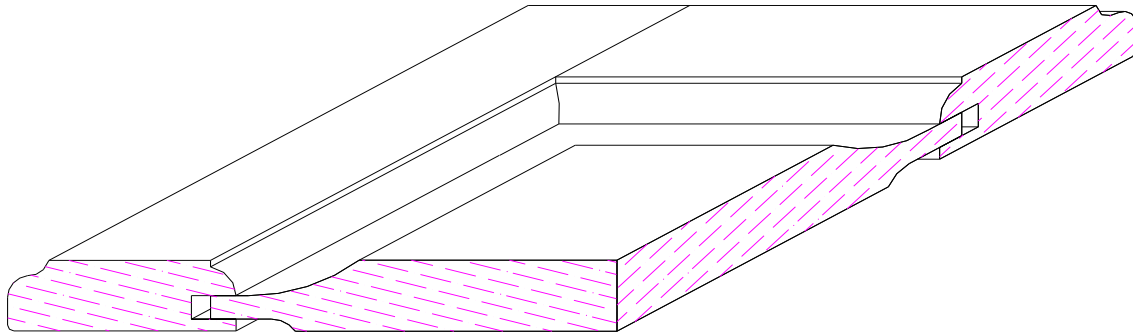

Door & Drawer Front Parts/Grain Direction

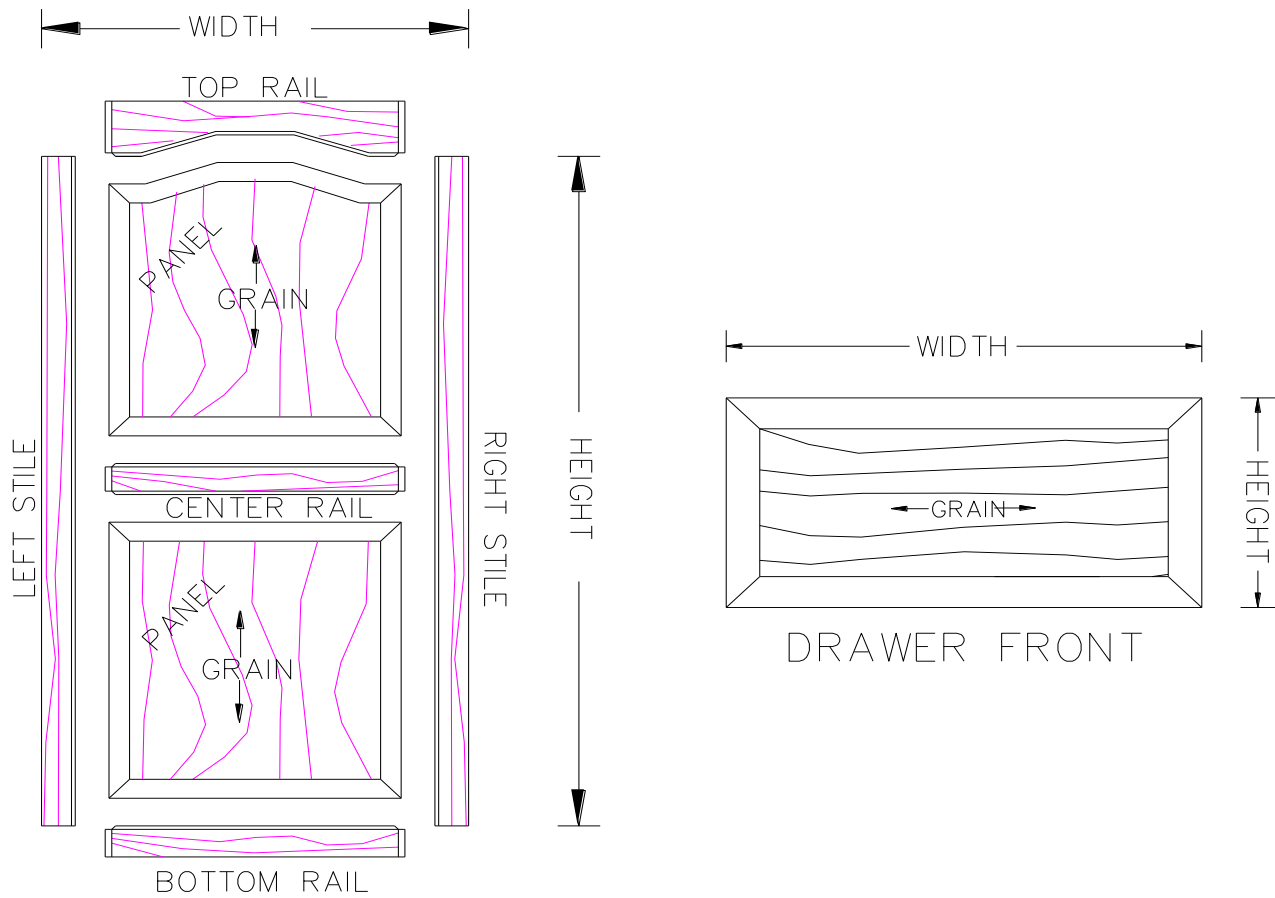

Exploded Door

Bevel Edge Option

15 degree bevel available on any edge profile

Example:

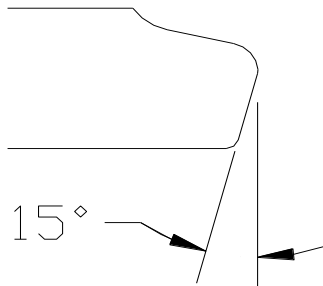

Bevel edge may not accommodate concealed hinge

Salice Hinge Boring Detail

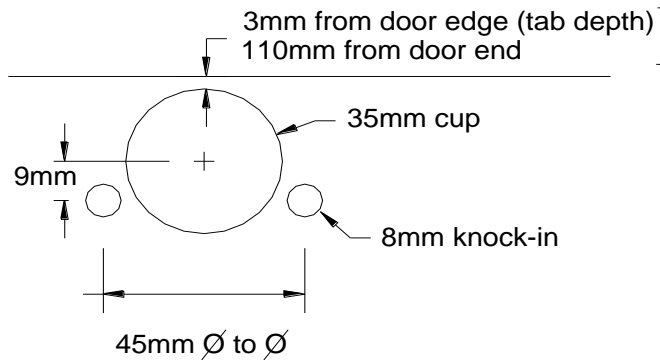

Blum and Grass hinge boring available, please specify tab depth, and distance from end of door.

Doors 48" and under will be bored for 2 hinges
 Doors over 48" will be bored for 3 hinges
 (see pricing)

Salice Hinge C2R9A99
 Salice Plate BAU3E49 } 1/2" Overlay

Standard Finger Pull Overlay

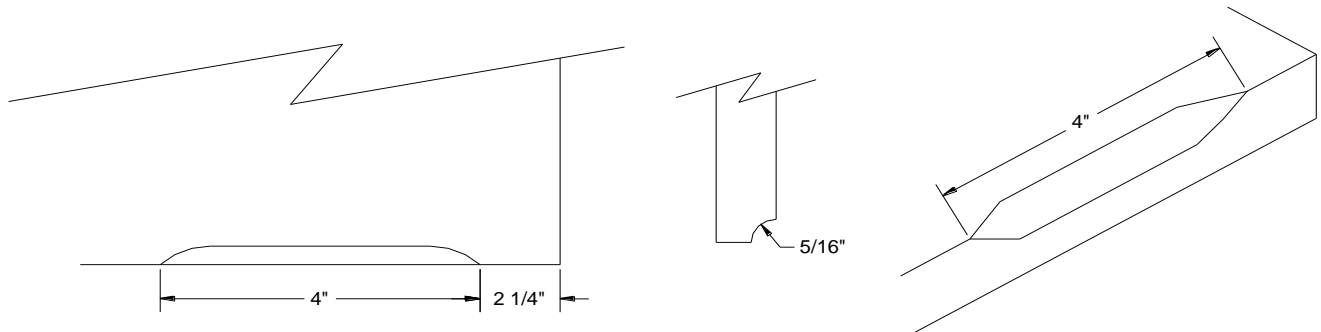

SLAB DOOR SPECIFICATIONS

- * Slab doors will have 2 battens, 1 3/4" wide, 6" from top & bottom, 1 3/4" from hinge side edge of door.
- * If door is less than 20" tall, the battens will be 3" from top & bottom.
- * If door is less than 10" tall, only 1 batten per door is used. It will be centered on door.
- * If door is more than 36" in height, 3 battens will be used. One centered, one 6" from top, one 6" from bottom.

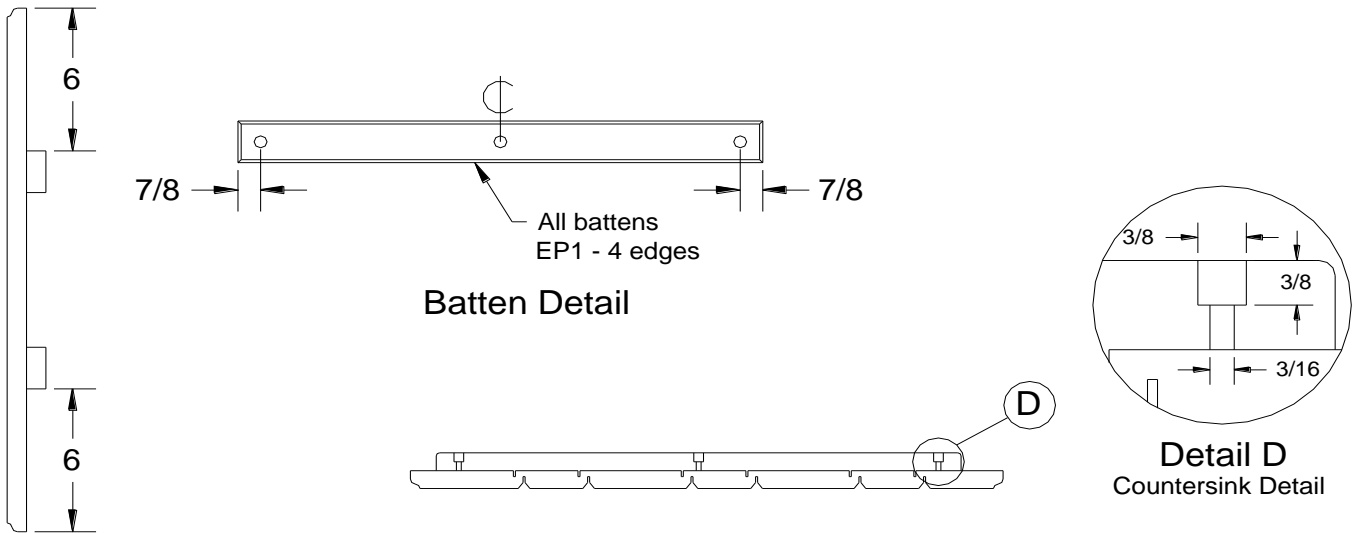

SLAB DOOR (SD)

SLAB DOOR - with v-groove (SDV)

Groove Centered then 1 1/2" Spacing
 other spacing options available

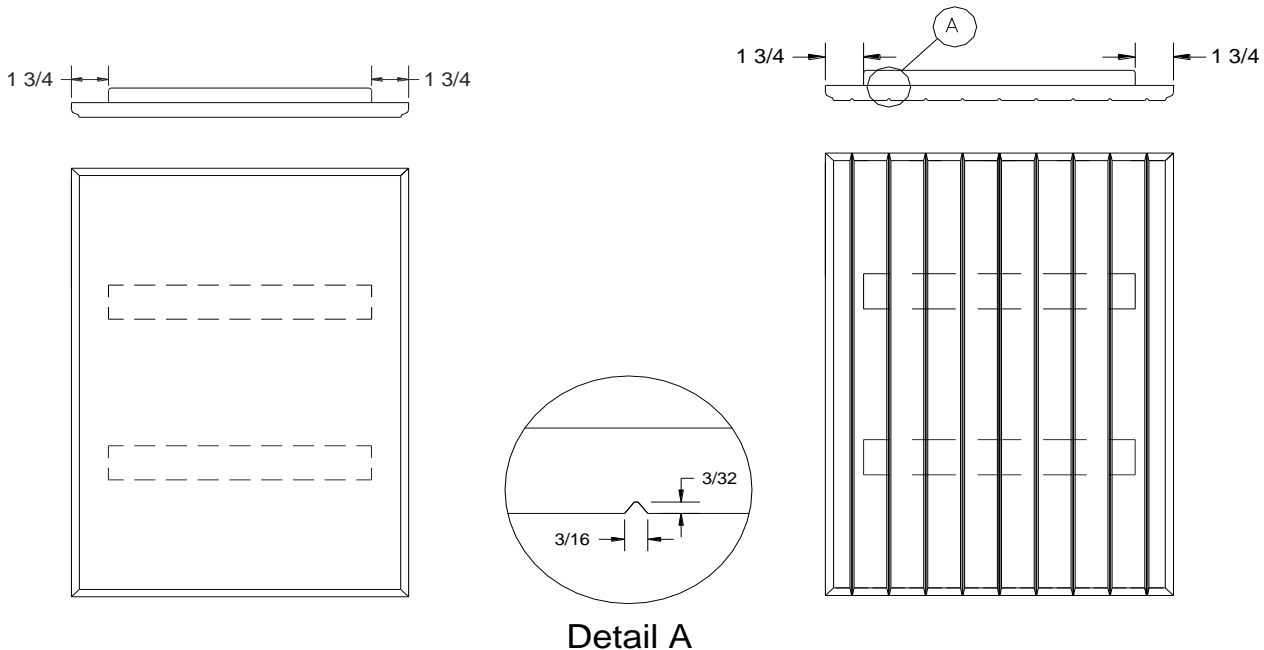

Detail A

SLAB DOOR - with bead (SDB)

Bead Centered then 1 1/2" Spacing
other spacing options available

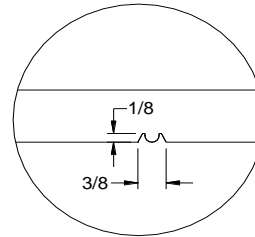
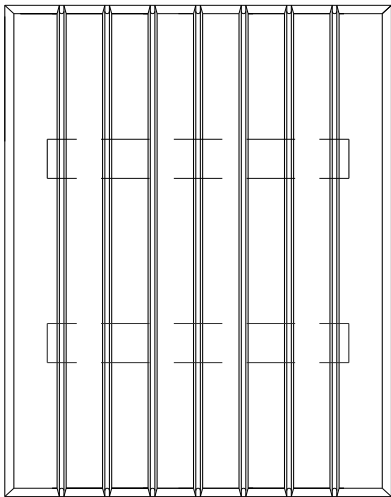
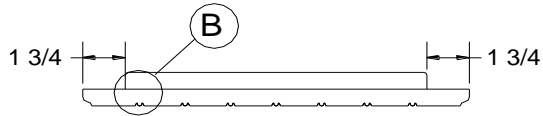

Detail B

SLAB DOOR - woodland (SDW)

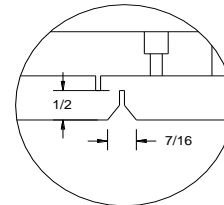
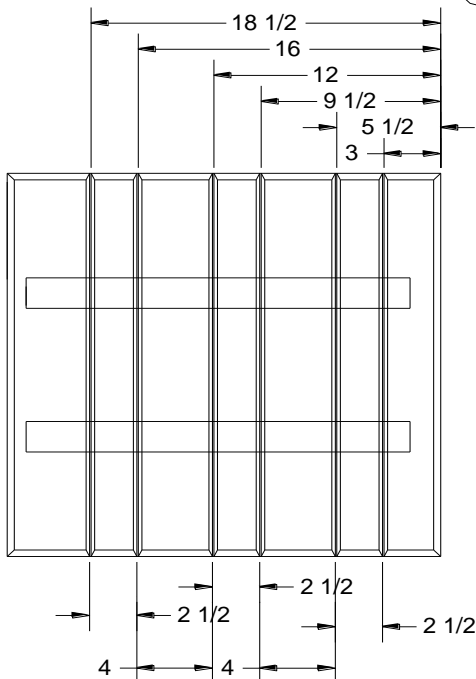
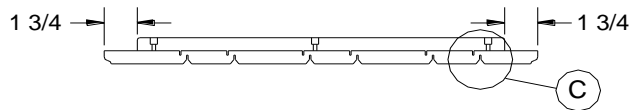

Detail C

Cope & Stick Wainscot Panels

Available in 1-6 Panels, adjust sku # according to # of panels

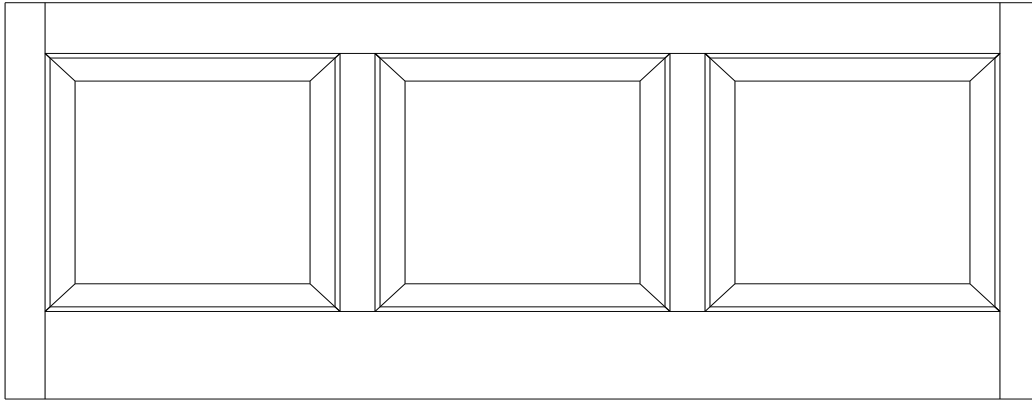

10WPR3
10WPF3

Mitre Wainscot Panels

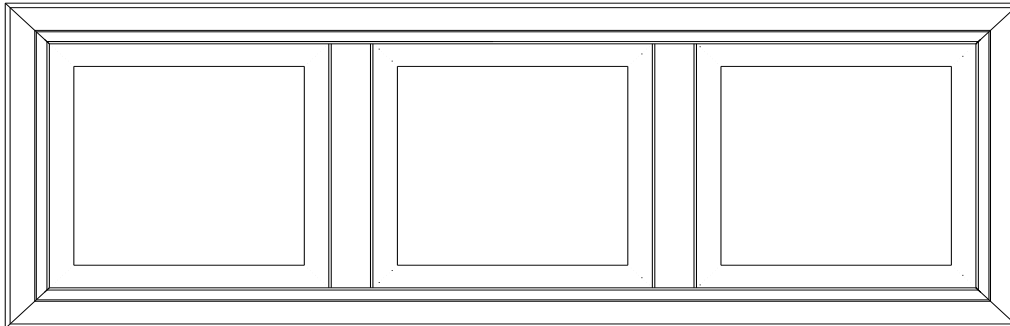

10WPR3M
10WPF3M

Custom Arch Panels

